

# FLEXY TWIN





# FLEXY TWIN

Modular system which allows you to cover large areas with a minimalist but at the same time innovative design.

An aluminum silver powder coated mast and one or two independently closable and tiltable awnings, provide shade where it is needed.

The system allows to connect several Flexy Twin. Ideal for contract (hotels, restaurants...) and residential use (villas, private gardens).

The canopy closes easily thanks to a simple pulley system.

The Flexy Twin can be supplied with both freestanding or ground insert bases.

The structure is made of aluminum with stainless steel hardware.

On request it can be equipped with lights. All FIM Products are designed and made in Italy using the finest materials for outdoor use, ensuring long life even under the harshest environmental conditions.





















• Independent opening of each canopy

• Possibility to cover large spaces joining several Flexy of different dimensions

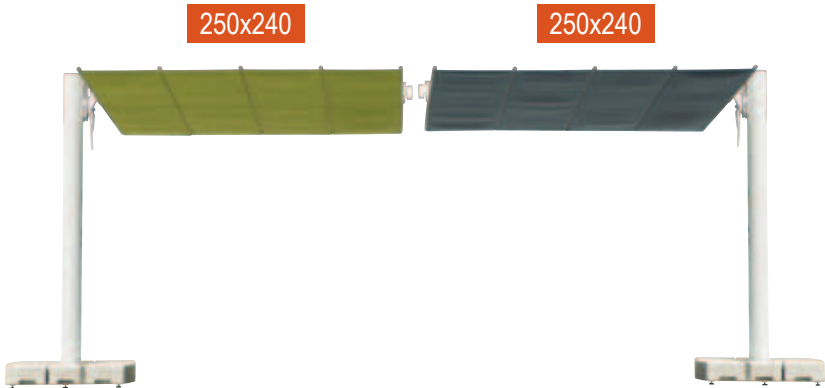

Size	
	250x523
	250x240





• Cover made of individual panels

• Independent tilt system for each canopy

Size	
	250X523
	250x240



250x523



250x240

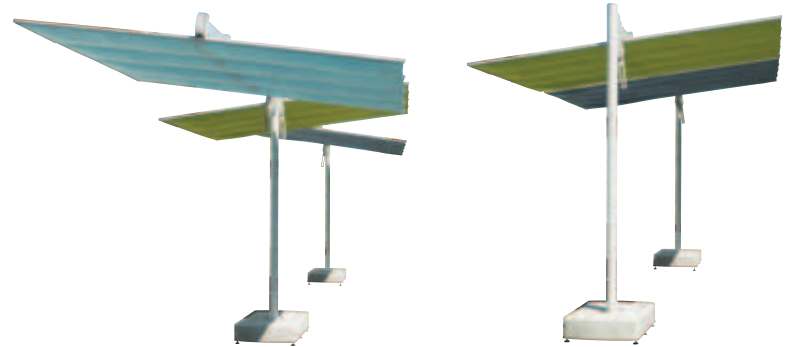

BASI



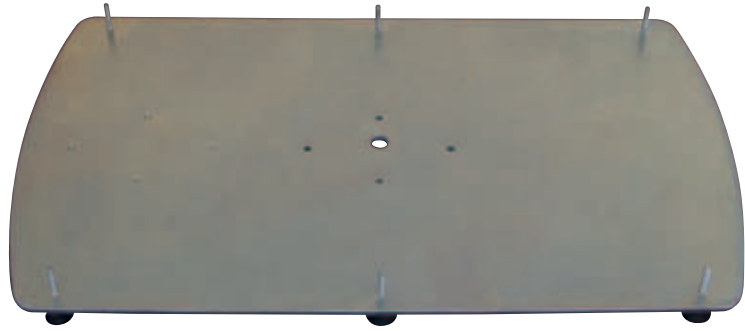

COD. GBASE004000

### BASE FLEXY TWIN

Hot dip galvanized steel base with adjustable feet.  
Requires dedicated concrete ballast or equivalent.



COD. GZAVO000200

### ZAVORRA IN CEMENTO FLEXY TWIN

Three cement ballasts for single base.



COD. GBASE003900

### BASE STYLO FLEXY TWIN

Steel ground insert base.  
Supplied fixing screws.



COLOURS





### **Acrylic fabric**

Water repellent and stain-resistant acrylic fabric. Available in Ecu (raw) colour.  
The ideal fabric, excellent value.  
290 gr/m<sup>2</sup>.

### **Solution dyed Acrylic fabric**

Designed for outdoor use, the solution (spun) dyed acrylic fabric resists salt water, chlorine and any type of harsh climate. Colours do not bleed and remain vibrant for a long time. A specific treatment makes the fabric water repellent, mould resistant and protects it from staining. This type of fabric resists the most extreme conditions and is suitable for year-round use in gardens, terraces, pool sides or on-board boats. It's definitely the top choice canopy fabric to select for your Product.  
UPF 50+ (UV Protection Factor) 280 gr/m<sup>2</sup>.

### **Micro-Mesh fabric**

This fabric allows natural air flow and has an excellent resistance to wind, ensuring a pleasant shading at the same time. Suggested to those who want a surely eye-catching alternative fabric. Its fibre composition, taking advantage of the "Precontraint" technology, guarantees an exceptional resistance to tearing, ultraviolet light and mould.  
410 gr/m<sup>2</sup>.

### **Airfim fabric**

Waterproof fabric assuring total protection from rain, which does not even permeate the stitches. A stain-resistant treatment contributes toward a better dirt resistance of the fabric, too. A regular wash with a neutral cleaning agent guarantees a long lifespan.  
UPF 80 (UV Protection Factor) 190 gr/m<sup>2</sup>.





Solution dyed Acrylic Fabric



S00 Natural  
5404



S01 Canvas  
5453



S03 Heather Beige  
5476

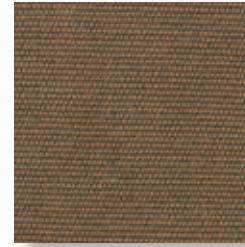

S15 Cocoa  
5425

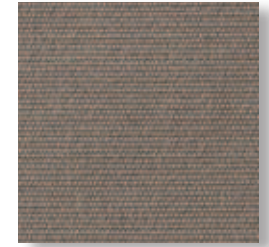

S04 Taupe  
3729



S10 Walnut  
5470

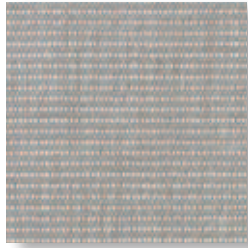

S16 Shingles  
3706

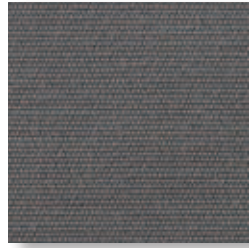

S18 Gray  
3737

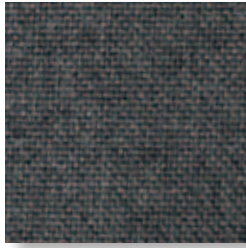

N01 Sooty  
10030

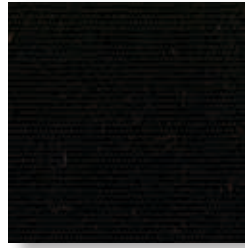

S13 Black  
5408



S21 Sunflower  
5457

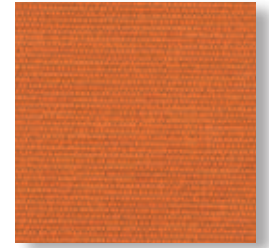

S11 Tuscany  
5417



S14 Logo Red  
5477



S19 Clay Court  
3744



S06 Macao  
3738



S07 Forest Green  
5446

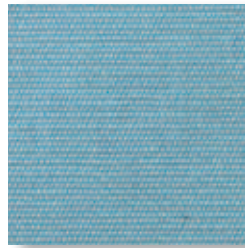

S05 Mineral Blue  
5420



S09 Navy Blue  
5439



S24 Narval  
3763



S28 Parma  
3761

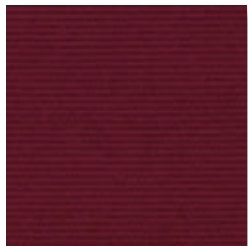

S29 Burgundy  
5436



*Acrylic Fabric*



A00 Ecrù



*Micro-Mesh-Fabric*



M03 Bianco  
5001

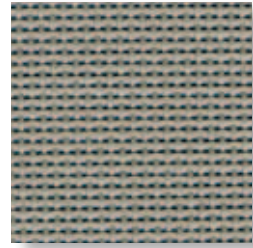

M01 Cenere  
5014

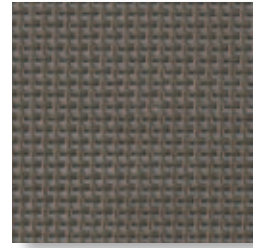

M02 Coffee  
5015

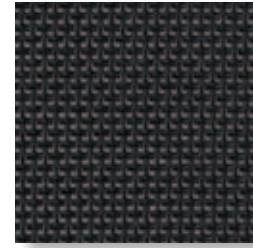

M00 Nero  
5005



*Airfim Fabric*



I05 Bianco  
9755



I01 Ecrù  
9883



I02 Verde  
9710



I03 Blue  
9545



I00 Bordeaux  
9879



I07 Gray  
9654



FINISHES

# Frame finishes





ANODIC

*The materials used have been specifically selected and treated to maintain our products durability and consistency over time.  
The colors may differ from the real ones.*



# TECHNICAL FEATURES

PRODUCT	SIZE (cm)	TECHNICAL FEATURES			
	250x523	STRUCTURE			
FLEXY TWIN	•	Aluminium gray	•	•	135 kg

FLEXY TWIN BASE FLEXY TWIN

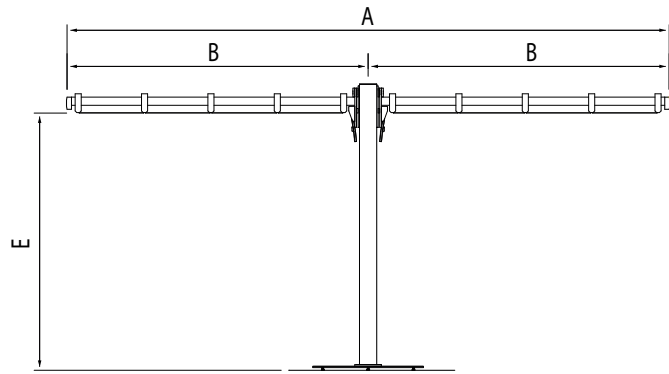

FLEXY TWIN BASE STYLO

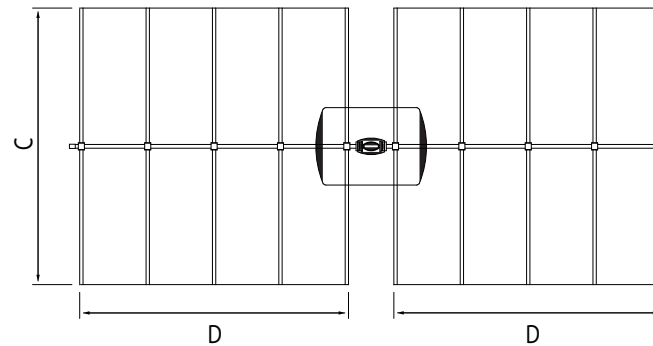
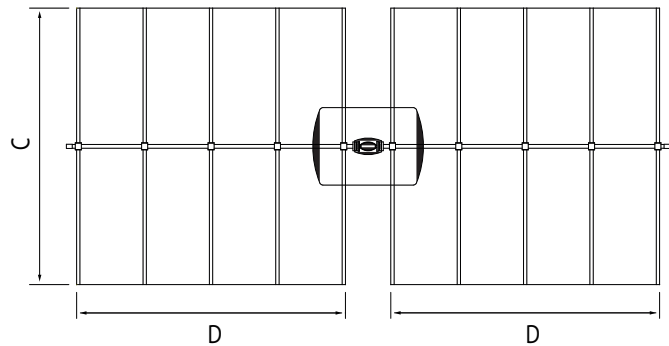
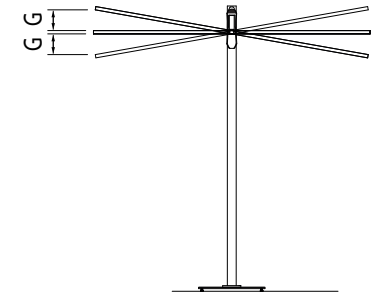
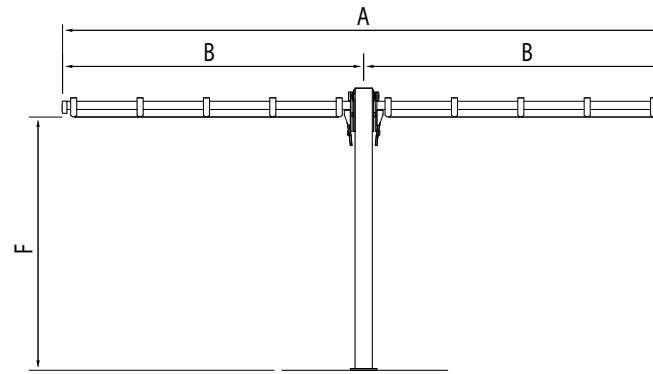

FLEXY TWIN MEASURE TABLE							
SIZE (cm)	A	B	C	D	E	F	G
250x523	544	272	250	243	232	228	18



GBASE004000

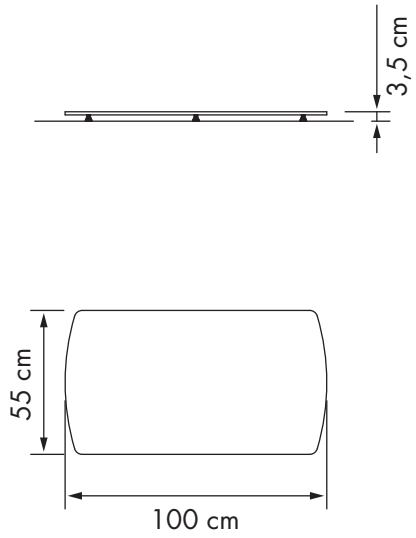

GBASE003900

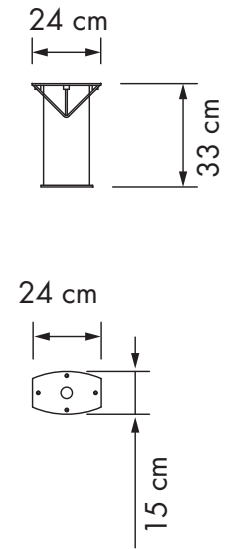

# SIMBOLS TABLE

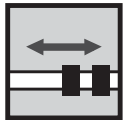

Single crossbar.



Tilt system of the canopy.

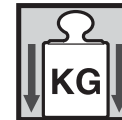

Minimum required base weight.

[WWW.FIM-UMBRELLAS.COM](http://WWW.FIM-UMBRELLAS.COM)

